

# CCpilot V1000 and V1200

## Technical Manual



## 1. Introduction

This technical manual provides important information regarding the *CCpilot V1000* and *V1200* product's hardware and its basic usage, hereinafter referred to as *CCpilot V1000/V1200*.

The *CCpilot V1000/V1200* are 10" and 12" display computer products featuring an i.MX 8QuadXPlus application processor.

For software and operating system specifics, please see additional documentation.

### Revision history

Rev	Date	Author	Comments
PA1	2022-01-03	MLG	Draft
1.0	2022-06-23	FMG	Release version
1.1	2023-06-02	ML	CAN Changes
1.1	2023-06-02	FMG	1.1 Release
1.2	2024-01-19	FMG	1.2 Release

## Contents

<b>1. Introduction.....</b>	<b>2</b>
<b>Revision history .....</b>	<b>2</b>
<b>2. Product models .....</b>	<b>4</b>
2.2. Document conventions .....	4
2.3. Identification .....	4
2.4. Environmental resistance .....	5
2.5. Product overview .....	5
2.6. Front side view .....	5
2.7. Rear side view .....	6
<b>3. Mounting and handling .....</b>	<b>7</b>
3.1. Mounting.....	7
3.2. Connecting to power supply .....	10
3.3. Cable installation .....	12
3.4. Special considerations .....	12
3.5. Handling and maintenance.....	13
3.6. Transportation.....	14
<b>4. Basic operation.....</b>	<b>14</b>
4.1. Turning ON .....	14
4.2. Turning OFF and suspending .....	14
4.3. Light sensor .....	16
4.4. Using the touch screen .....	16
4.5. Status notification .....	16
4.6. System related error codes.....	16
4.7. Display related error codes .....	17
<b>5. Interface overview .....</b>	<b>19</b>
5.1. Touch screen .....	19
5.2. Light sensor .....	19
5.3. RGB status LED.....	19
5.4. Buzzer.....	19
5.5. CAN .....	19
5.6. Ethernet .....	20
5.7. USB .....	20
5.8. Bluetooth and Wi-Fi.....	20
<b>6. Connectors .....</b>	<b>21</b>
6.1. M12 connectors .....	21
6.2. Connector 1 - Power and CAN M12 pinout .....	22
6.3. Connector 2 - CAN M12 pinout .....	22
6.4. Connector 3 - Ethernet M12 pinout .....	23
6.5. Connector 4 - USB M12 connector pinout.....	23
6.6. Connector 5 - USB-C.....	24
<b>7. Specifications .....</b>	<b>24</b>
7.1. Technical data .....	24
7.2. Environmental specifications.....	27

7.3. EMC specification..... 28  
 7.4. Weight and dimensions..... 29  
**Technical support..... 31**  
**Trademarks and terms of use..... 32**

## 2. Product models

This documentation is applicable for all CCpilot V1000/V1200 models. These models are:

- CCpilot V1000 2CAN.
- CCpilot V1000 4CAN Wi-Fi and Bluetooth.
- CCpilot V1200 2CAN.
- CCpilot V1200 4CAN Wi-Fi and Bluetooth.

These models share the same level of performance, hardware architecture, TFT, enclosure and connectors. The PCB is the same for all versions but may be populated differently.



### 2.1.1. Customized models

The platform enables additional customization of hardware and software. Described herein are the features included in product models described above. Additional features in customized models will be documented separately.

Contact CrossControl for customization inquiries.

## 2.2. Document conventions

This document uses the following conventions:

Description	Appearance	
Important information		(Exclamation symbol)
Differences between product models		(Observe' symbol)

Text formats used in this document are described in the table below:

Format	Use
<i>Italics</i>	<i>Names, designations, and references</i>
<b>Bolded</b>	<b>Important information</b>

## 2.3. Identification

Each device has identification labels with serial number, part number and revision which identifies your unique device. This information is required when communicating with CrossControl regarding Technical support and Service/Repair needs.

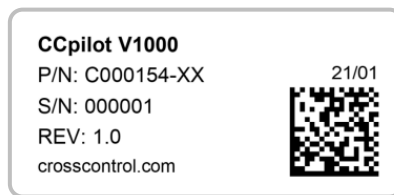

Figure 1: Identification labels

## 2.4. Environmental resistance

The CCpilot V1000/V1200 products has been designed to manage tough environmental demands. The focus, from design through components selection, has been to provide a reliable and robust device.

Thorough testing has been performed to ensure compliance to a broad range of applicable regulatory requirements and to meet user demands of a ruggedized product for machinery control.

A complete list of the standards to which the product has been tested for compliance can be found in chapters 8.2 and 8.3.

## 2.5. Product overview

This chapter contains illustrations of the CCpilot V1000/V1200 showing the location of external connectors, indicators etc. Connectors are described in more detail in chapter 7. Additional mechanical information can be found in chapter 8.4.

## 2.6. Front side view

The devices feature either a 10" or 12" display with projected capacitive (PCAP) touch-sensor. There is also a light sensor and an RGB status LED in the front. The light sensor enables automatic dimming of the display and the RGB status LED shows operation modes or fault indications.

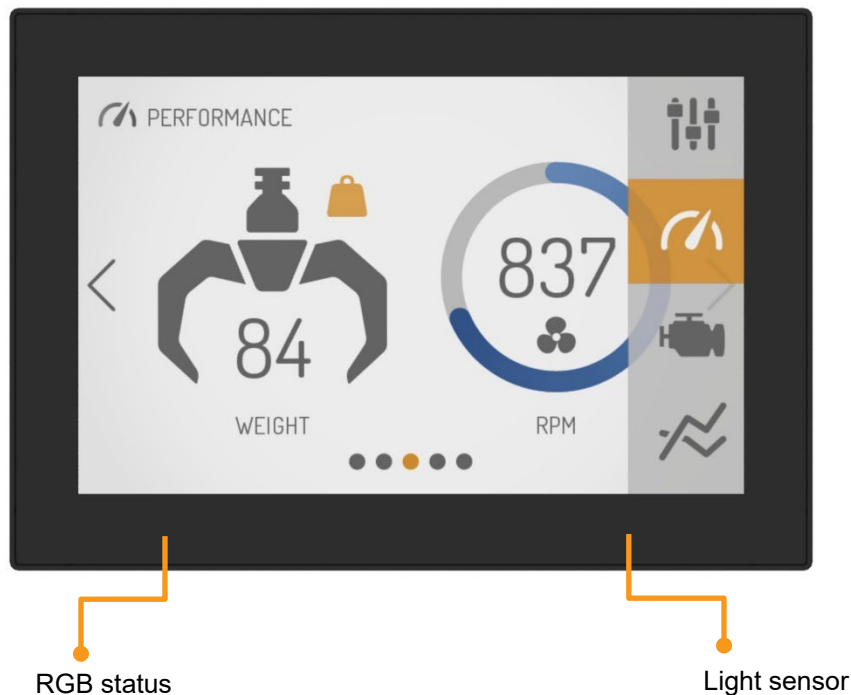

Figure 2: CCpilot V1000/V1200 front side view

## 2.7. Rear side view

The rear side contains external connectors of type M12 and USB-C, mounting holes for either a fastener in accordance with VESA 75 (M6) or custom bracket for panel mounting and a GORE-TEX® membrane for ventilation.

Depending on exact product model the CCpilot V1000/V1200 product has either three or four M12 connectors. The M12 connector for CAN channels 3 - 4 is only mounted on the product instances holding 4 CAN interfaces.



**Note** on product models with revision 1.0 or lower, M12 connector 1 contains CAN 1 and 4 interface and M12 connector 2 contains CAN 2 and 3 interface.

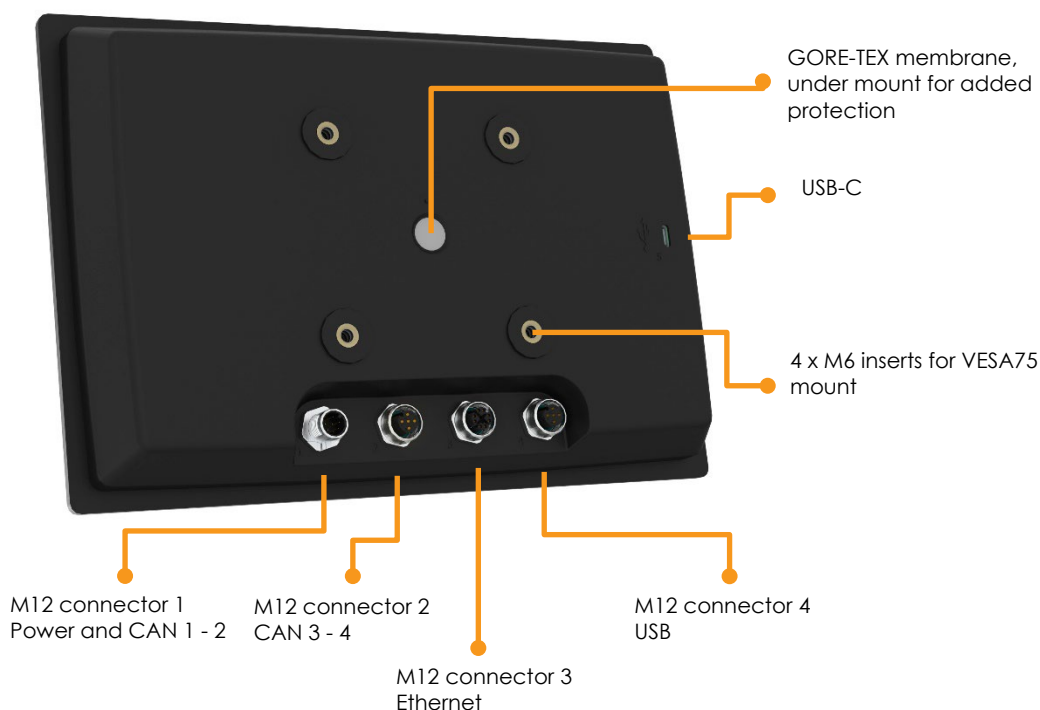

Figure 3: CCpilot V1000/V1200 rear side view

### 3. Mounting and handling

This chapter contains recommendations for installation, handling and maintenance of the product.

#### 3.1. Mounting

CCpilot V1000/V1200 supports two different mounting methods, standardized VESA75 or a panel mount. These two mounting methods are described separately below.

For both fastening methods, use the appropriate 4 pc. M6 button head screw of type MRT (Torx) The recommended torque for the screws is 3.0-3.5 Nm. Using fluid locker or locking washers (split ring, toothed lock, etc.) is required for proper mounting. Ensure that the M6 mounting screws are clean and dry before mounting.



Note that the depth of the threaded holes is 12mm. Be careful not to use too long screws which may damage the device when tightened. It is also very important to use a fastening plate with holes that are not larger in diameter than 7 mm so that the plate is flush with the threaded inserts to avoid pulling out the threaded inserts from the unit.

### 3.1.1. VESA 75 mount

CCpilot V1000/V1200 can be mounted using a RAM mount, i.e. RAM-D-2461U, square base 2.25" ball mount and accessories of choice which allows adjustment of the display's position and angle. Screw length should be 16mm.



Figure 4: VESA 75 mount

### 3.1.2. Panel mount

Alternatively, the device can be mounted in a panel cut-out using a panel mounting bracket (article number C000154-65)



Figure 5: Mounting bracket



The mounting bracket is designed for a panel thickness of 1.5 - 3.0 mm. Panel cut out dimensions are shown in the figure below. A drawing in DXF-format for precision cutting of panels is available upon request. Screw length should be 12mm.

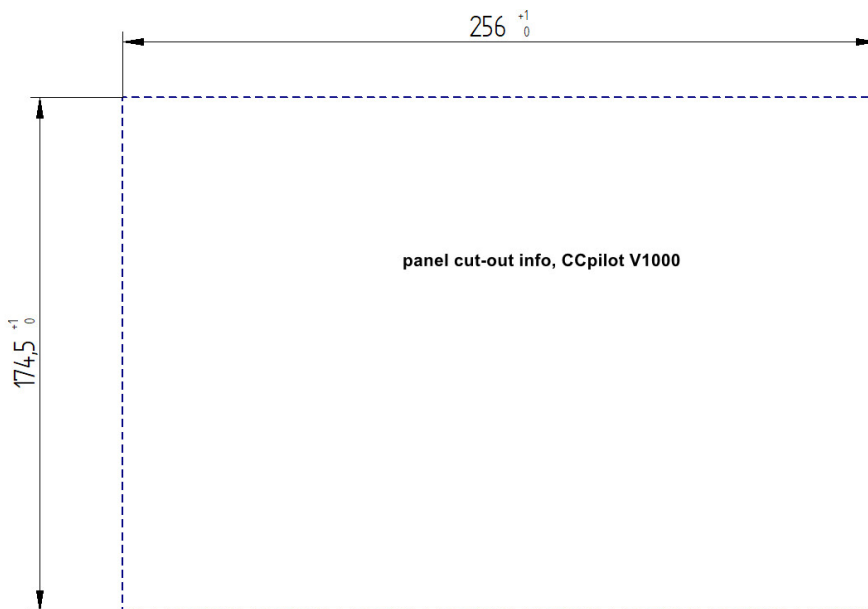

Figure 6: Panel cut-out CCpilot V1000

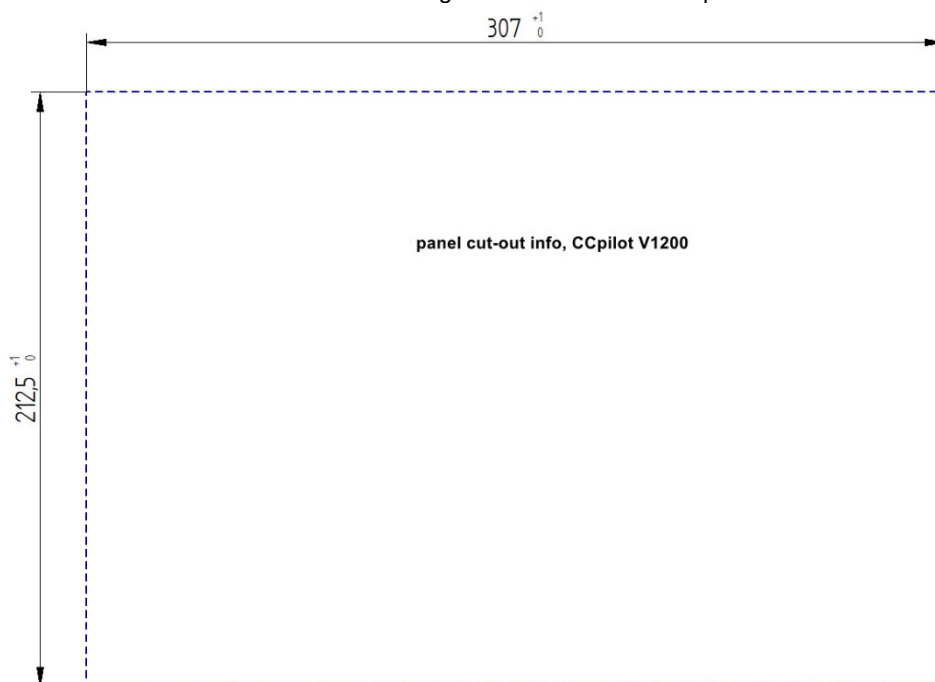

Figure 7: Panel cut-out CCpilot V1200



Ensure that CCpilot V1000/V1200 is mounted to a smooth, flat surface. Fastening the unit to an uneven surface may stress the enclosure, damage the outer flange, or possibly even flex the circuit board inside, leading to a premature failure.

## 3.2. Connecting to power supply

This chapter describes how the CCpilot V1000/V1200 is preferably connected to the power supply of the equipment it is installed in. The principle is the same for vehicular and stationary installations.



Carefully read through the following sub-chapters. They are critical for designing and adapting the electrical system of the equipment in which the CCpilot V1000/V1200 is installed. Connector pinouts are found in chapter 7.

### 3.2.1. Wire gauge

Wire gauge for the power supply should be dimensioned with respect to the total load current, the cable length required, and the worst-case voltage drop allowed, considering the minimum operational voltage of the device.

- Current consumption of the CCpilot V1000/V1200 device is found in chapter 8.1.
- The wire gauge for the power supply is recommended to be at least 0.75 mm<sup>2</sup> /AWG 18 for “normal” loads.

### 3.2.2. External fuse



To prevent cable fire in case of short circuit, an external fuse must always be used when powering the device from a high current capable power source, for example a vehicle battery.

- The fuse shall be located as close to the battery/power source as practically possible. A recommendation is to place the fuse at a maximum distance of 15 cm (6 inches) from the (+) terminal of the source.
- Fuse rating shall be dimensioned with respect to wire gauge, maximum current consumption and the inrush current of the device. Refer to chapter 8.1 for fuse rating details.
- As a guideline, a slow acting fuse with 2-3 A current rating should be used.
- Remember to also apply fusing for the on/off control wiring, see chapter 4.2.4.

### 3.2.3. External key switch signal

The device's key switch signal should be connected to the positive supply line via the vehicle's ignition key switch.

- The wire gauge for the key switch signal shall be dimensioned to handle the total switch current and the fuse type and rating shall be selected to prevent cable fire in case of cabling short circuit.
- As a guideline, a slow acting fuse in the range of 100-500 mA for the key switch signal should be sufficient for most practically usable wire gauge.

### 3.2.4. Application example

Below is an application example schematic of the CCpilot V1000/V1200 power supply connection.

If the system has a main switch for completely disconnecting the battery (S1 in schematic below), the device's power supply and key switch signal shall be connected after the main switch.



It is **not** recommended to disconnect the battery without shutting down the device first - since doing so will immediately switch off all internal voltages, regardless of ongoing operations. Any information which was not saved to flash memory will be lost when disconnecting the battery. However, no physical damage will be caused to the device by disconnecting the battery.

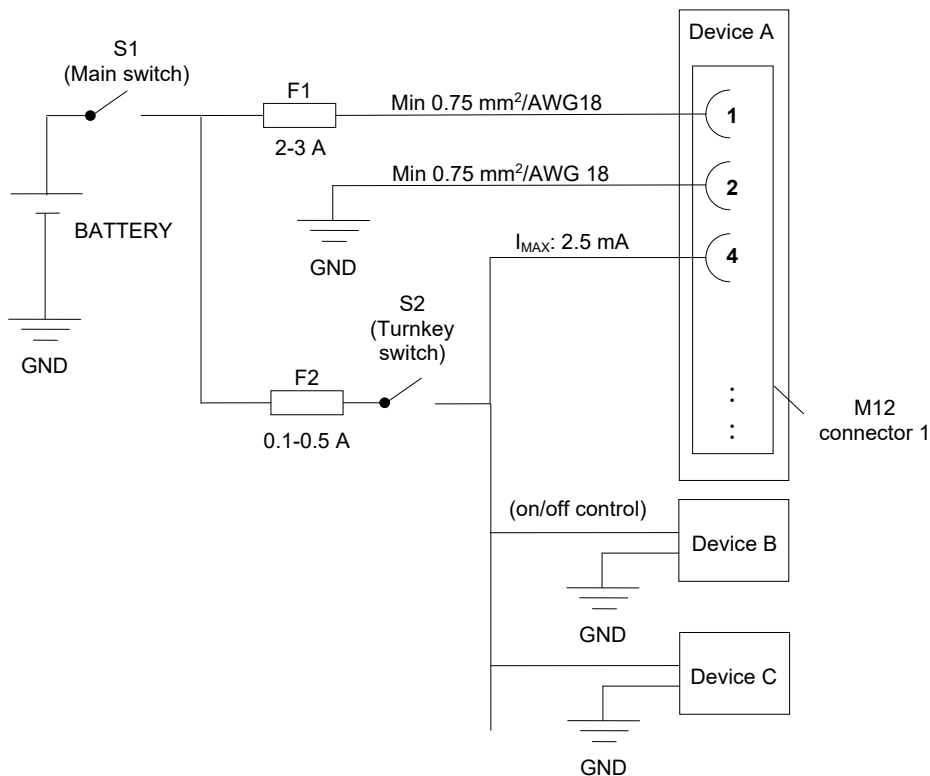

Figure 8: Schematic example for power supply installation of a CCpilot V1000/V1200 device in a vehicle. The ignition switch (S2) can be shared by several devices (Device X, Y, ...)

By connecting the power supply according to the example above, the CCpilot V1000/V1200 device will automatically start up when the key switch (S2) is closed and shut down when the switch is opened.



Note that the on/off behaviour of the CCpilot V1000/V1200 described here is the default configuration. Its response to the on/off signal may be altered using the CCAux API, see chapter 5.1 for more details.



Be advised that the device consumes a small amount of power from the main supply also when shutdown. Therefore, if the device has been attached for a long period of time without the vehicle motor running, the battery may be drained, resulting in inability to start up the vehicle. A

main switch for disconnecting the device's main supply is highly recommended in such situations.

### 3.3. Cable installation

Cables should be installed in such a way that they do not run any risk of being damaged, pinched or worn.

- Avoid excessive bending and twisting of cables.
- Use strain-relief on cables near the device to minimize stress on cables and connectors.
- Properly secure the connectors to give reliable contact and sealing and to avoid unnecessary strain.
- Shielded cables are recommended and, in some cases, necessary to ensure reliable communication and appliance with agricultural EMC standards.

#### 3.3.1. Recommendations for cable shields



To achieve electromagnetic compliance and stable operation of the system, shielded cables are required for Ethernet and USB interfaces.

### 3.4. Special considerations



To ensure proper and reliable operation, and to retain the device's IP-classification, the below recommendations must be followed:

- The device should be placed in a way that prevents direct and continuous exposure to water or proximity to hot-air vents.
- To enable sufficient cooling, the device must be installed in a way that allows ambient air to circulate around it. A clearance of at least 50 mm around the device is recommended.
- To maintain IP classification, all connectors must have a mating external connector attached. Protective caps shall be used on all non-mated connectors. Please note that the protective caps mounted on the connectors are for transportation protection only.
- The device has a ventilation membrane, refer to Figure 3 for the location. For proper ventilation of the device, dirt and water must be prevented from accumulating and covering the membrane. Be cautious not to insert objects which may puncture the membrane. Doing so will violate the IP-classification and void the warranty of the device.
- Install the device and any cables attached in a way that they are not subject to excess vibrations or other potentially harmful stress.
- Loose fasteners are a common cause for excessive vibration. Fasteners may come loose due to improper mounting techniques such as omitting thread lockers (fluid locker or locking washers) or by over/under-tightening. Proper tightening requires dry, clean fasteners and a torque wrench.
- If the device is exposed to chemicals, water, dirt or other pollutants, it is recommended to have it cleaned off as soon as possible. See chapter 4.5.1 for cleaning instructions.

### 3.5. Handling and maintenance

Handle the device with care and pay attention to the following handling instructions:



- Disconnect all cables to the device during welding or when performing other service to the machine imposing a risk of damaging electronic devices.
- Service and repair to the device shall only be made by authorized personnel. If the device is opened by unauthorized personnel, its warranty will be void.
- Scratches or other damages may occur to the display surface if it is exposed to sharp objects, abrasives or heavy impacts. This must be avoided to increase the longevity of the screen.
- The internal eMMC flash storage has a limited number of write cycles. Therefore, it is recommended that the amount of writing to flash is limited within software applications.<sup>1</sup>
- Always consider personal safety when installing and operating the product. For example, in vehicle installations, CrossControl does not recommend that the product is being actively operated by the driver when a risk of injury to people or damage to property is present.

#### 3.5.1. Cleaning



To ensure proper and reliable functionality over time, pay attention to the following cleaning instructions and precautions:

- Wipe the device clean from dirt using a soft damp cloth, preferably of microfiber type. Larger amount of dry dust may be swept off using a soft brush before wiping clean.
- Avoid using alkaline, alcoholic or other potentially adverse chemicals for cleaning as doing so may damage the device. However, small amount isopropyl alcohol may be used for removing harsh stains.
- Avoid spraying or by other means applying larger amount of water or alcohol directly to the device. Instead, lightly dampen a cloth before using it for cleaning the device.
- After cleaning, make sure that the device surface is left dry.
- Never use high-pressure air, vacuum, water or steam to clean the device.

#### 3.5.2. Real time clock battery



Time and date information is stored in a memory sustained by an internal back-up battery. The battery is a 3V 1000mAh high operating temperature Poly-carbonmonofluoride Lithium battery. The expected lifetime of the battery is approximately 20 years. The battery is not replaceable.

---

<sup>1</sup> The eMMC is used in pseudo SLC mode and implements both static and dynamic wear levelling to achieve the best reliability. The number of program/erase cycles is between 20k to 60k depending on the manufacturer and temperature. Our recommendation for the application software is to temporary cache in RAM and to write larger chunks of data to the eMMC. This recommendation is not specific to eMMC but is applicable to all flash memories.

### 3.6. Transportation

When transporting the device, it is recommended to use the original packaging. Make sure that protective caps are used on all non-mated connectors. The safe storage temperature range [-40°C to +80°C] must be adhered to.

## 4. Basic operation

This section covers basic operation of the product such as start-up, shut down, suspend, resume, display operation and status notification.



Observe that the behaviour of the external on/off control is user configurable in terms of:

- Enabling/disabling functionality
- Timing parameters
- Edge or level triggered

Notifications during start-up are indicated by the status LED or buzzer delivering different patterns. The buzzer is used for audible operation alerts as well as for various error notifications, see chapter 5.6 for error code details.

The status notification behaviour in the operational state of the device is configurable by user applications. Described herein are the factory default behaviours of the on/off controls and the status notification.

### 4.1. Turning ON

The CCpilot V1000/V1200 product can be started in different ways:

1. Connecting the external on/off control signal to a positive supply input (at or above approximately 6V).
  - When started this way, the on/off signal must remain asserted. De-assertion of this signal will shut down the device unless configured otherwise.
2. It is possible to configure the device to automatically start up whenever external power is applied (i.e. without using any on/off control).
  - a. Note that this function is disabled as factory default.

For resuming the device from suspend mode, see chapter 5.2.

While starting up the device, it will give a short beep and the status LED will flash with 2 Hz. When the device enters operational state the status LED will stop flashing and be turned on.

### 4.2. Turning OFF and suspending

There are several ways to turn off the CCpilot V1000/V1200 device and also alternatives to enter suspend mode instead of completely shutting down the device.

#### 4.2.1. Shutting Down

There are two ways to shut down the device, provided that it is in normal operational state when the action occurs:

1. By disconnecting the external on/off control for more than a specified time, i.e. using the turn-key functionality.
  - The time-out is user configurable (default is set to 4 seconds).
  - If the on/off signal is brought back high again while the device is shutting down, it won't restart automatically. A low-to-high transition must occur after the device has fully shut down to make a restart.
2. By operating system shutdown requests.



To ensure that data is not lost nor the flash memory corrupted, it is recommended that all necessary data be saved, and all programs closed before the device is shut down.

**Note** that the device won't shut down from Suspend mode by these actions. See chapter 5.2.2 for details of Suspend mode and wakeup.

When performing any of the above, the CCpilot V1000/V1200 device will shut down.

#### 4.2.2. Suspending/resuming

Suspending and resuming are a faster alternative to shutting down and starting up the device. In suspend mode, the data remains in RAM memory and the device must be connected to external power supply to maintain its state.

Suspend mode can be entered in two ways:

1. By disconnecting the external on/off control, for example using the turn key functionality.
  - By factory default, disconnecting the external on/off control is configured to shut-down the device.
2. By selecting the operating systems suspend alternative.



Observe that the product current consumption in suspend mode is higher than in shut-down mode.

To prevent a vehicles or machines battery from draining when the device is suspended, a user configurable time-out can be set for how long the unit shall stay in suspend mode before it automatically shuts down. The default suspend time-out is set to 60 minutes.

Resuming from suspend mode can be done by the following event:

1. A low-to-high transition of the external on/off control, for example using the turn-key functionality.

Configuration of suspend and resume is done through the CCSettingsConsole application or using the CCAux API. See the software guide for details.

### 4.3. Light sensor

The CCpilot V1000/V1200 contains a light sensor that can be used to automatically adjust the display brightness, depending on the ambient light conditions. As depicted in Figure 2, the light sensor is located in the lower right corner of the front surface. When automated dimming is enabled, the level of sensitivity can be adjusted.



The screen brightness can also be manually controlled directly from user applications through APIs.

For proper operation it is important to keep the light sensor opening clean and unobstructed visibility.

### 4.4. Using the touch screen

To reduce reflections when operating in very bright conditions, the touch screen's protective glass is covered with an anti-glare layer. Do not use any sharp or abrasive objects when interacting with the touch screen.

Basic usage of the capacitive touch screen should be intuitive for most users. Note that the touch screen is capable of handling multiple simultaneous touches.

### 4.5. Status notification

The CCpilot V1000/V1200 contains a status LED, in the front, used for notification while starting up, shutting down or in other operational states. The buzzer may also be used for user notifications. See Table 1 for a description of the status notification behaviour for different operational states.

Table 1: LED and buzzer indication for different operational states

Operational state	LED indication	Buzzer notification
Device off	OFF	-
Power applied, device off	OFF	-
Starting up	Yellow flashing, 2 Hz	Short beep
Operating (started up)	Static green	-
Suspended	Yellow flashing, 0.2 Hz	-
Shutting down	Static yellow	-
Rebooting	Static yellow	-
Rescue mode, starting	Static orange	Short beep
Rescue mode, running	Green flashing, 2 Hz	-
OTG mode (OS update)	Yellow flashing, 0.5 Hz	-
Forced update mode (OS update)	Orange flashing, 0.5 Hz	-
SS firmware update mode	Static yellow	-



Observe that the status notification behaviour in both the start-up and operating states is configurable by user applications running on the device.

### 4.6. System related error codes

The status LED in the front is also used for indicating system related error codes by emitting a blue blinking pattern after shutdown of the device. The device may be started again when in this mode, by the key switch signal. Depending on the nature of the error, the device may start or go back into error indication.



When an error occurs, the device is immediately shut down and the error is reported by blinking a specific number of times corresponding to an error code (see table of error codes). The blinks will be in a continuous sequence of 1 Hz blinks, with a longer pause of two seconds after the specific number of blinks, allowing the end user to count the number of blinks. Refer to Figure 9 below for an example.

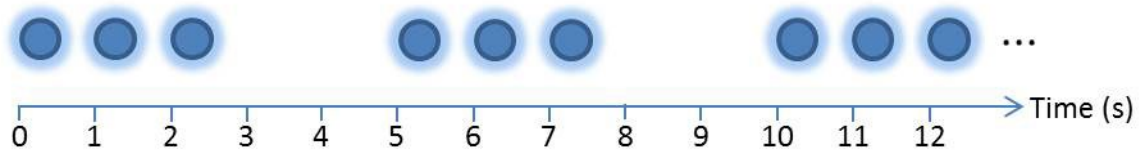

Figure 9: Example of the blinking pattern for error code 3

When an error occurs, an error code is also immediately saved to persistent storage (FRAM). If several errors occur before the device is shut down, only the code of the first error is saved and reported. The error code in persistent storage can be read and cleared from a user application.

Refer to Table 2: CCpilot V1000/V1200 system related error codes for a complete listing of the error codes.

The number of blinks is important information if the unit is sent in for service/repair.

Table 2: CCpilot V1000/V1200 system related error codes

Error code	Error code name	Likely problem cause
1	TEMP_ABOVE_MAX_ERROR	Temperature is above max limit
2	TEMP_BELOW_MIN_ERROR	Temperature is below min limit
3	TEMP_IMPOSSIBLE_VALUE_ERROR	PCBA temperature sensor malfunction
4	TEMP_MEAS_TIMEOUT_ERROR	PCBA temperature sensor malfunction
5	WD_RESET_ERROR	Watchdog timer reset
6	VMAIN_BELOW_LIMIT_ERROR	Main power supply voltage is below min limit
7	VMAIN_ABOVE_LIMIT_ERROR	Main power supply voltage is above max limit
8	MCU_HARD_EXCEPTION_ERROR	MCU hard fault exception
9	NVM_CORRUPTED_DATA_ERROR	Non-volatile memory data is corrupted

#### 4.7. Display related error codes

Unlike system related errors, display related errors are not indicated by the LED. When a display related error occurs, an error code is immediately saved to persistent storage (EEPROM). The error log in persistent storage can store up to 32 error codes and is readable from the ccsystemreport application.

Refer to Table 3: CCpilot V1000/V1200 display related error codes for a complete listing of the error codes.

The error log is important information if the unit is sent in for service/repair.

Table 3: CCpilot V1000/V1200 display related error codes

Error code	Error code name	Likely problem cause
0	ERR_NO_ERROR	Default entry, log entry never written.
1	ERR_INVALID_LOG_ENTRY	Invalid log entry, i.e failed to read the log entry from EEPROM.
2	-	-
3	-	-
4	ERR_LS_INIT	Failed to initialize light sensor.
5	ERR_LS_I2C	Failed to access light sensor over I2C.
6	ERR_EEPROM_INIT	Failed to initialize eeprom.
7	ERR_DISP_ROT_AT_STARTUP	Failed to set display rotation at startup (V1000 only).
8	ERR_RCC	Failed to configure clocks.
9	ERR_TOUCH_I2C	Failed to access touch controller over I2C.
10	ERR_TOUCH_NUM_CONTACTS	Max number of contacts exceeded.
11	ERR_HID_START_TRANS_FAILED	Failed to start a touch data transfer.
12	ERR_HID_RX_BUFF_OVERRUN	I2C HID receive buffer overrun.
13	ERR_HID_REPORT_BUFF_OVERRUN	Touch report buffer overrun.
14	ERR_MP_RX_BUFF_OVERRUN	MP I2C receive buffer overrun.
15	ERR_MP_TX_BUFF_OVERRUN	MP I2C transmit buffer overrun.
16	ERR_MP_RX_WR_BUFF_OVERRUN	MP write buffer overrun.
17	ERR_MP_CMD_INVALID	Invalid/unknown command sent from MP.
18	ERR_LOG_INIT	Failed to read out error log from EEPROM.
19	ERR_EEPROM_DEFAULTS	Failed to write parameter default values to EEPROM.
20	ERR_EEPROM_PARAM_WRITE_FAILED	Failed to write EEPROM parameter.
21	ERR_EEPROM_PARAM_READ_FAILED	Failed to read EEPROM parameter.
22	ERR_BL_OFF_SEQ	Backlight OFF sequence failed.
23	ERR_BL_ON_SEQ	Backlight ON sequence failed.
24	ERR_TFT_EN_SEQ	TFT enable sequence failed.
25	ERR_TOUCH_EN_SEQ	Touch enable sequence failed.
26	ERR_DISP_OFF_SEQ	Display OFF sequence failed.
27	ERR_PARAM_BUFF_OVERRUN	EEPROM parameter buffer overrun.
28	ERR_I2C_CALLBACK	Failed to register callbacks for I2C transfer.
29	ERR_HID_IRQ_TIMEOUT	Touch interrupt not cleared by MP.

## 5. Interface overview

This section describes the various interfaces of the product. Main part of these interfaces can be accessed via software APIs. These are described in more detail in the CCpilot V1000/V1200 Software Guide.

### 5.1. Touch screen

The front panel contains a projective capacitive (PCAP) touch screen, which is capable of handling multiple simultaneous touches.

### 5.2. Light sensor

There is a light sensor in the front panel used by user applications or used with the built-in automated function for dimming of the display brightness.

For light sensor location, see Figure 2. Refer to the CCpilot V1000/V1200 Software guide for details about accessing the light sensor data from within user applications.

### 5.3. RGB status LED

The CCpilot V1000/V1200 contains a status LED in the front used for notification while starting up, shutting down or in other operational states.

### 5.4. Buzzer

The CCpilot V1000/V1200 has a built-in buzzer that can be used for audible notifications. The buzzer is software controllable with configurable volume and frequency.

For buzzer location see Figure 3. See chapter 5.5 for buzzer notification events. Refer to the CCpilot V1000/V1200 Software guide for details about controlling the buzzer from user applications.

### 5.5. CAN

Depending on product model CCpilot V1000/V1200 has two or four CAN-FD ports that meets CAN ISO 11898 2.0B (29-bit extended identifier) and supports bit rates up to 5 Mbps.

Two of the CAN channels are always present within the M12 connector 1 and the optional two are present within the M12 connector 2.



**Note:** CAN4 interface has limitations and does not support CAN FD.

The CAN4 channel has the possibility for wake on CAN function. Refer to the CCpilot V1000/V1200 Software guide for details.



**Note** that Internal EMI filters on CAN High/Low signals have a capacitance of 100 pF (typ) which deviates from the ISO 11898 standard and implies some limitations on the CAN bus topology (maximum bus length, number of CAN nodes etc.) when running at high bit-rates (above 250 kbps).

The ports feature highly protected CAN transceivers which are tolerant for bus short-circuits to main supply voltage and ground.

There is no device-internal CAN bus termination, therefore bus termination must be applied externally.

## 5.6. Ethernet

CCpilot V1000/V1200 has one Ethernet interface in M12 connector 3 supporting 10BASE-T/100-BASE-TX/FX/1000-BASE-T and Auto-MDIX.

The Ethernet interface is galvanic isolated with 1.5 kV<sub>AC</sub> insulation voltage.



Shielded cables should be used to ensure reliable communication and electromagnetic compliance. As with all Ethernet enabled devices, connecting the device to a public network environment may impose an IT security threat.

## 5.7. USB

The CCpilot V1000/V1200 has two USB ports. One of them is a USB 2.0 port located in the M12 connector 4 and the other one is a USB 3.0 port located in a USB-C connector on the backside of the device.

The USB-C port supports a USB OTG interface, i.e. acting as both host and device. Using the port in USB device mode is only for OS updates through a connected PC with the appropriate tool installed.

In USB host mode, both USB ports can be used for application data transfer or the connection of a peripheral such as a mouse or keyboard.

The M12 USB 2.0 port can supply up to 500 mA and the USB-C port up to 900mA. Both ports are internally over current and short circuit to ground protected. Shielded cable shall be used to ensure reliable communication and electromagnetic compliance.



Due to the M12 connector specification, USB data signal integrity cannot be guaranteed with higher speeds than full-speed USB (12 Mbps). However, hi-speed operation is supported by the USB host controller.

## 5.8. Bluetooth and Wi-Fi



Product models for CCpilot V1000/V1200 with 4 CAN, Wi-Fi, and Bluetooth have a built in Bluetooth and Wi-Fi module to facilitate wireless communication to and from the device. The Linux based operating system in the CCpilot V1000/V1200 includes a software Bluetooth stack for easy application development including adding Bluetooth functionality.

Refer to the CCpilot V1000/V1200 Programmers manual guide for details about implementing Bluetooth and Wi-Fi functionality in user applications.

Table 4: Bluetooth and Wi-Fi module and communication specifications:

Items	Specification
Radio module certificates	FCC/IC/CE/RCM
Antenna Type	Internal
Wireless specification	802.11 a/b/g/n/ac
Bluetooth version	V5.0 Dual Mode – BR / EDR / LE
Frequency range	2.402 – 2.480 GHz, 5.15 – 5.825 GHz
Temperature range	The Bluetooth and WiFi module is operational in the CCpilot V1000/V1200's full temperature range
Range	Circa 100 meters
Max Transmit Power	Class 1 +8dBm from antenna

## 6. Connectors

There are either three or four M12 connectors depending on product model. These are marked 1, 2, 3 and 4 and are accessible from the rear of the device. Refer to Figure 10 for an overview of the connectors. For product models with three M12 connectors, connector 2 is not mounted.

### 6.1. M12 connectors

Pay close attention to the coding; excessive force should not be used when mating the connectors.

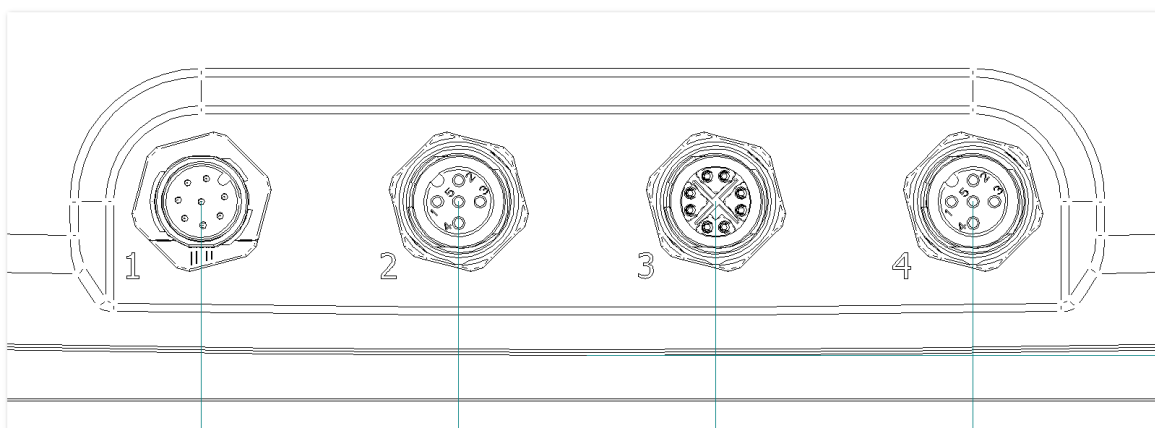

Figure 10: M12 connector pinout, 8-pin A-coded, 5-pin A-coded, 8-pin X-coded and 5-pin A-coded.



The M12 connector pins/receptacles are made of a gold-plated copper-zinc alloy. It is recommended to use gold-plated pins/receptacles in the mating connectors. Using different plating in the cable connectors might cause galvanic corrosion. The M12 contact body is made of polyamide and the sleeve around it is made of nickel-plated zinc.



Note that all three M12 connectors must be mated with its corresponding cable connector or a proper blind plug to maintain the IP-classification.

## 6.2. Connector 1 - Power and CAN M12 pinout

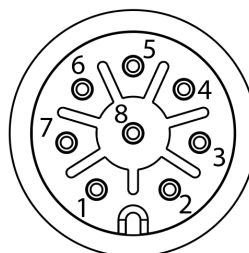

Power and CAN M12 Connector	
Matching plug: Female, 8-pin, A-coded with shield	
Pin	Signal
1	Power supply
2	Ground
3	*Force pin for USB serial download mode of the i.MX 8X
4	Key switch signal
5	CAN1 high
6	CAN1 low
7	CAN4 high
8	CAN4 low

Table 5: Power and CAN M12 connector pinout

\*Pin for forcing the USB serial download mode of the i.MX 8X for flashing of boot and/or image. Active high. Leave floating or grounded for normal operation.

## 6.3. Connector 2 - CAN M12 pinout

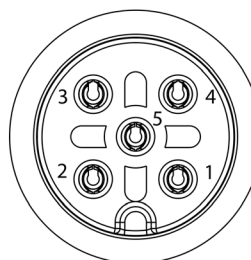

CAN2-3 M12 Connector	
Matching plug: Male, 5-pin, A-coded with shield	
Pin	Signal
1	Ground
2	CAN3 high
3	CAN3 low
4	CAN2 high
5	CAN2 low

Table 6: CAN M12 connector pinout

### 6.4. Connector 3 - Ethernet M12 pinout

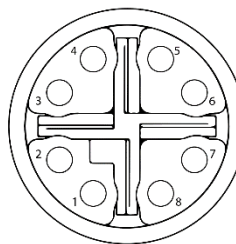

Ethernet M12 Connector	
Matching plug: Male, 8-pin, X coded	
Pin	Signal
1	DA +
2	DA -
3	DB +
4	DB -
5	DD +
6	DD -
7	DC -
8	DC +

Table 7: Ethernet M12 connector pinout

### 6.5. Connector 4 - USB M12 connector pinout

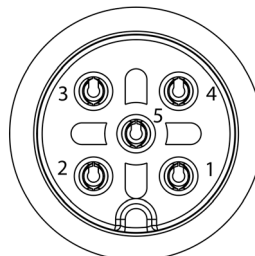

USB M12 Connector	
Matching plug: Male, 5-pin, A-coded with shield	
Pin	Signal
1	VBUS
2	Data-
3	Data+
4	Ground for shield
5	Ground

Table 8: USB M12 connector pinout

## 6.6. Connector 5 - USB-C

USB 3.0 port located in a USB-C connector on the backside of the device. From the factory a dust cap is mounted for protection.

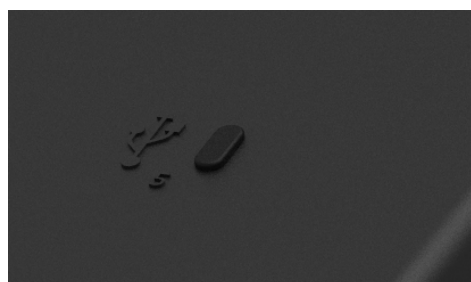
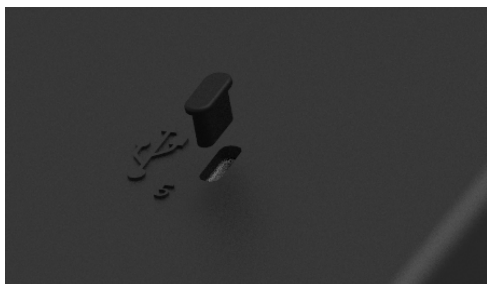

## 7. Specifications

### 7.1. Technical data

Temperature specification	
Operating	-30 to +70 °C
Storage	-40 to +80 °C

Kernel	
Main Processor	NXP™ i.MX8 QuadXPlus: ARM 64-bit, 1200MHz, Cortex®-A35
Co-processor	STMicroelectronics STM32G070RBT6, Cortex®-M0+
Data storage	8 Gbyte, Industrial grade eMMC <sup>(Note)</sup>
RAM memory	2 Gbyte, LPDDR4



**Note:** The eMMC is used in pseudo SLC mode and implements both static and dynamic wear levelling to reach the best reliability. The number of program/erase cycles is between 20k to 60k depending on the manufactures and temperature. Our recommendation for the application software is to temporary cache in RAM and to write larger chunks of data to the eMMC. This recommendation is not specific to eMMC but is applicable to all flash memories.



Power Supply		
<b>Supply voltage</b>		
Nominal	12 V <sub>DC</sub> or 24 V <sub>DC</sub>	
Voltage range	6 V <sub>DC</sub> ...36 V <sub>DC</sub>	
<b>Power consumption</b>		
<b>CCpilot V1000</b>	<b>V<sub>in</sub> = 12 V<sub>DC</sub></b>	<b>V<sub>in</sub> = 24 V<sub>DC</sub></b>
Typical, operating	1.1A (typ)	540 mA (typ)
Max, operating	2.0A	1.1A
Suspend to RAM	42 mA (typ)	23 mA (typ)
Shutdown(wake on CAN)	350 µA (typ)	200 µA (typ)
Shutdown	250 µA (typ)*	125 µA (typ)*
* This assumes that the ignition signal is disconnected from supply voltage.		
<b>CCpilot V1200</b>	<b>V<sub>in</sub> = 12 V<sub>DC</sub></b>	<b>V<sub>in</sub> = 24 V<sub>DC</sub></b>
Typical, operating	1.4A (typ)	670 mA (typ)
Max, operating	2.2A	1.2A
Suspend to RAM	42 mA (typ)	23 mA (typ)
Shutdown(wake on CAN)	350 µA (typ)	200 µA (typ)
Shutdown	250 µA (typ)*	125 µA (typ)*
* This assumes that the ignition signal is disconnected from supply voltage.		
<b>Inrush current</b>		
<b>CCpilot V1000</b>	<b>V<sub>in</sub> = 12 V<sub>DC</sub></b>	<b>V<sub>in</sub> = 24 V<sub>DC</sub></b>
Duration ca 2 ms	< 2.4 A	< 2.4 A
<b>CCpilot V1200</b>		
Duration ca 2 ms	< 2.4 A	< 2.4 A
<b>External fuse recommendation</b>		
Current rating	2-3 A*	(including maximum external loads)
* This assumes that the fuse is in accordance with IEC 20127 i.e. can be continuously operated at 100% of rated current.		
<b>CAN interfaces</b>		
Type	Non-isolated, ISO 11898-1, CAN 2.0B	
CAN transceiver	NXP TJA1051T/3	
Baud Rate	Configurable 20 kbit/s – 1 Mbit/s.* CAN FD mode up to 5 Mbit/s. * Internal CAN bus filters have a capacitance of 100pF (typ) as stated in the J1939 specification. This puts restrictions on the CAN bus topology considering bus length, number of CAN nodes etc. when running at bit-rates higher than 250 kbps. The CAN4 interface has bus load bandwidth limitations for CAN baud rates above 75 kbps. The transmission capacity decreases with increasing baud rates.	
Protection	Short circuit protected to -36V to +36V	
<b>USB 2.0 interfaces</b>		
Type	1x USB 2.0 compatible host ports	
Speed	Full-speed (12 Mbps) and Hi-speed USB (480 Mbps) is supported.	
VBUS supply	5.0 V, 0.5 A per port, internally over-current (typically 0.7 A) and short-circuit to ground protected.	
<b>USB 3.0 interfaces</b>		

Type	1x USB-C compatible host ports
Speed	Superspeed 5 Gbit/s
VBUS supply	5.0 V, 900mA, internally over-current (typically 1.25A) and short-circuit to ground protected.

Ethernet	
Type	10/100/1000 Mbps Ethernet compatible with 10BASE-T, 100BASE-TX and 1000-BASE-T Ethernet standards. Auto-MDIX support.
Insulation voltage	1500V <sub>AC</sub> .

Buzzer	
Frequency range	700 – 10 kHz (SPL peak at 2830 Hz)
SPL range	75 dBA (max) at 0.1 meter (typ, 2500 ± 200Hz) The buzzer is located on the back (connector side) of the device and the typical SPL varies dependent on the acoustic properties of the installation environment and mounting hardware.

Software	
Operating system	CC Linux
Additional software	CCAux API, CCSettingsConsole. Refer to the <i>CCpilot V1000/V1200 Software Guide</i> and <i>Programmer's guide</i> for details.

Display CCpilot V1000	
Size	
Diagonal size 10"	10.1 inch widescreen
Active area 10"	216.96 x 135.60 mm
Pixel pitch 10"	0.1695 x 0.1695 mm
Type	TFT a-Si (IPS type)
Aspect ratio	16:10
Resolution	WXGA, 1280x800
Colour depth	24 bit (16.7M colors)
Contrast ratio	600:1 (min), 800:1 (typ)
Viewing angle	Horizontal: ± 85° Vertical: ± 85°
Backlight	
Type	LED
Brightness	900 cd/m <sup>2</sup> (typ)
LED Life time	50 000 h (typ) before brightness is reduced with 50 % (when operated with full brightness at 25 °C) (Note that sustained higher operating temperatures affects LED lifetime.)
Cover glass	

Protective glass thickness	1.8 mm
Surface treatment	Etched Anti-Glare
Surface Hardness	6H

### Display CCpilot V1200

<b>Size</b>	
Diagonal size 12"	12.1 inch widescreen
Active area 12"	261.12 x 163.20 mm
Pixel pitch 12"	0.204 x 0.204 mm

<b>Type</b>	
Type	TFT AHVA (IPS type)
Aspect ratio	16:10
Resolution	WXGA, 1280x800
Colour depth	24 bit (16.7M colors)
Contrast ratio	800:1 (min), 1000:1 (typ)
Viewing angle	Horizontal: ± 89° Vertical: ± 89°

<b>Backlight</b>	
Type	LED
Brightness	1275 cd/m <sup>2</sup> (typ)
LED Life time	70 000 h (typ) before brightness is reduced with 50 % (when operated with full brightness at 25 °C) <small>(Note that sustained higher operating temperatures affects LED lifetime.)</small>

<b>Cover glass</b>	
Protective glass thickness	1.8 mm
Surface treatment	Etched Anti-Glare
Surface Hardness	7H

## 7.2. Environmental specifications

Environmental Test	Test standard	Notes
Dry Heat	IEC 60068-2-2:2007	Operating: +70°C, 24h Storage: +80°C, 24h
Damp Heat	IEC 60068-2-30:2005	Operation: +25°C / +55°C >95% RH 6*24h
Cold	IEC 60068-2-1:2007	Operating: -30°C, 24h Storage: -40°C, 24h
Change of temperature	IEC 60068-2-14:2009	-30°C to +70°C, 5°C/min 1hr hold time, 20 cycles
Vibration	IEC 60068-2-64:2008	0.02 g <sup>2</sup> /Hz 5-2000 Hz 3x3h
Shock	IEC 60068-2-27:2008	± 25 g / 6ms ±3x2500 impulses
Enclosure Ingress Protection	IEC 60529:2014	IP65, IP66 and IP67



Any changes or modifications to the device not expressly approved by CrossControl could void the environmental classification, warranty, and user's authority to operate the equipment.

### 7.3. EMC specification

The CCpilot V1000/V1200 device has been tested for Electromagnetic Compatibility according to the following standards EN ISO 14982, EN ISO 13766-1 and EN ISO 13766-2.

EMC Test	Test standard	Notes		
Electrical Transients	ISO 7637-2:2011 ISO 16750-2:2012 12 V system	<b>Pulse</b>		<b>Level</b>
		1		-75V
		2a		+37V
		2b		+10V
		3a		-112V
		3b		+75V
		Starting profile		+4.5V
	Load dump		+65V, Ri = 2Ω	
	24 V system	1		-450V
		2a		+55V
		2b		+20V
		3a		-220V
		3b		+220V
		Starting profile		+12V
Load dump			+123V, Ri = 2Ω	
ESD immunity	ISO 10605:2008	Air	± 15 kV	
		Contact	± 8 kV	
Radiated RF immunity <sup>(1)</sup>	ISO 11452-2:2019	<b>MHz</b>	<b>Level</b>	<b>Modulation</b>
		200-1000 1kHz	100 V/m	80%AM,
		1000-2000	30V/m	PM
		2000-2400	10V/m	PM
	ISO 11452-4:2011 (BCI)	2400-2700	5V/m	PM
		<b>MHz</b>	<b>Level</b>	<b>Modulation</b>
Radiated RF emission <sup>(1)</sup>	ISO 13766-1:2018	1-200	100 mA	80%AM, 1kHz
		<b>MHz</b>	<b>Narrow-b.</b>	<b>Broad-b.</b>
		30-75	<b>dBμV/m</b>	<b>dBμV/m</b>
		75-400	54-44	64-54
		44-55	54-65	
		400-1000	55	65

(1) Compliance to RF immunity and RF emission standards require use of shielded cables for Ethernet and USB interfaces.

EMC tests are performed at 24 V<sub>DC</sub> supply voltage unless other levels are specified in test standards.

System level compliance to relevant EMC standards may be affected by external factors like mounting, omitting the use of shielded cables etc.

### 7.4. Weight and dimensions

Attribute	Description	Comments
CCpilot V1000 Dimensions	265 x 184 x 41 mm	(W x H x D)
CCpilot V1200 Dimensions	317 x 222 x 41 mm	(W x H x D)
CCpilot V1000 Weight	1.0 kg	
CCpilot V1200 Weight	1.6 kg	
Mounting holes Spacing	VESA 75	
Thread dimension	M6	
Thread depth	12 mm	
Enclosure material	PBT + PC plastic, impact modified and flame retarded	

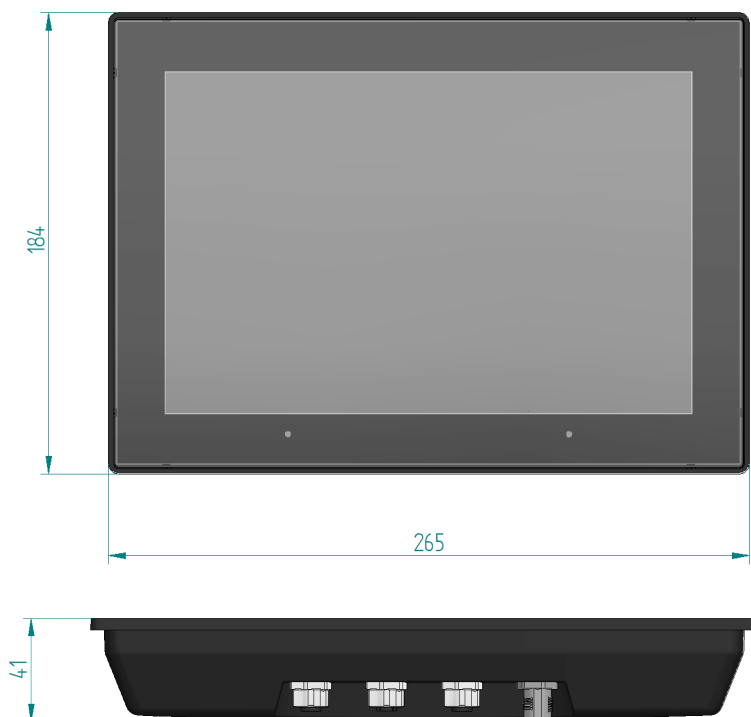

Figure 11: CCpilot V1000 dimensions.

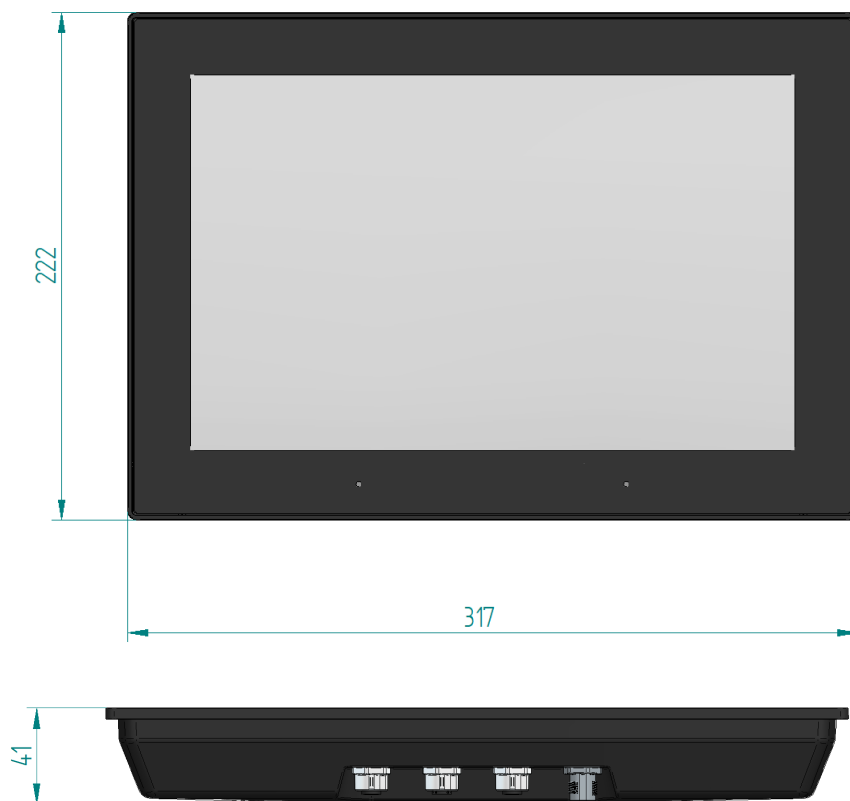

Figure 12: CCpilot V1200 dimensions

## Technical support

Additional sources of information are available on the CrossControl support site:

<http://support.crosscontrol.com>

Contact your reseller or supplier for help with possible problems with your device. In order to get the best help, you should have your device in front of you and be prepared with the following information before you contact support.

- Part number and serial number of the unit, which you find on the identification label, see Figure 1.
- Date of purchase, which is found on the invoice.
- The conditions and circumstances under which the problem arises.
- Error codes signaled by the internal buzzer.
- Possible error messages which are shown.
- Device log files (if possible).
- Information regarding possible external equipment which is connected to the device.

## Trademarks and terms of use

© 2024 CrossControl

All trademarks sighted in this document are the property of their respective owners.

- NXP™ is a trademark of NXP Semiconductors Inc.
- Arm® is a registered trademark of ARM Limited.
- Linux® is a registered trademark of Linus Torvalds in the U.S. and other countries.
- CrossControl and CCpilot are trademarks of CrossControl AB.

CrossControl is not responsible for editing errors, technical errors or for material which has been omitted in this document. CrossControl is not responsible for unintentional damage or for damage which occurs as a result of supplying, handling or using of this material including the devices and software referred to herein. The information in this handbook is supplied without any guarantees and can change without prior notification.

For CrossControl licensed software, CrossControl grants you a license under CrossControl intellectual property rights to use, reproduce, distribute, market and sell the software, only as a part of or integrated within, the devices for which this documentation concerns. Any other usage, such as, but not limited to, reproduction, distribution, marketing, sales and reverse engineer of this documentation, licensed software source code or any other affiliated material may not be performed without written consent of CrossControl.

CrossControl respects the intellectual property of others, and we ask our users to do the same. Where software based on CrossControl software or products is distributed, the software may only be distributed in accordance with the terms and conditions provided by the reproduced licensors.

For end-user license agreements (EULAs), copyright notices, conditions, and disclaimers, regarding certain third-party components used in the device, refer to the copyright notices documentation.